

Test: (2020) Primary 5 Science (Term 4) - Henry Park

Points: 61 points

Name: _____

Score: _____

Date: _____

Signature: _____

Select multiple choice answers with a cross or tick:

Only select one answer

Can select multiple answers

Question 1 of 60

Primary 5 Science (Term 4)

2 pts

For each question, four options are given. One of them is the correct answer.

Study the two groups of animals, P and Q, shown below.

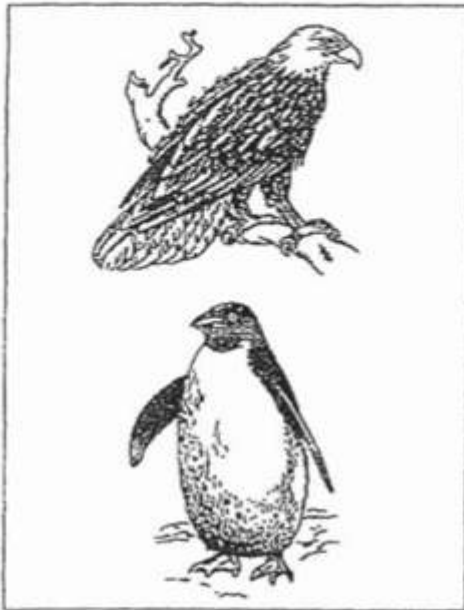
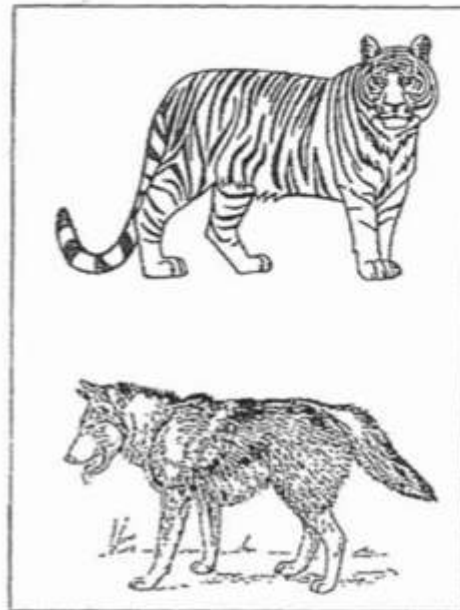
Group P**Group Q**

Which of the following correctly describes the characteristics of the two groups of animals shown above?

	Group	Covered with feathers	Covered with hair	Lay eggs	Give birth to live young
(1)	P		✓	✓	
(2)	P	✓			✓
(3)	Q	✓		✓	
(4)	Q		✓		✓

A tick (✓) shows that the group has the characteristic stated.

- A) 1
 B) 2
 C) 3
 D) 4

Question 2 of 60

Primary 5 Science (Term 4)

2 pts

The table describes the stages of the life cycles of four animals, K, L, M and N.

Observation	Animal			
	K	L	M	N
It has a 4-stage life cycle	✓			
The eggs are laid in water	✓	✓	✓	
The young resembles the adult		✓		✓

A tick (✓) indicates that the characteristic is observed.

Which of the animals is likely to be a grasshopper?

- A) K
- B) L
- C) M
- D) N

Question 3 of 60

Primary 5 Science (Term 4)

2 pts

The diagram shows a plant cell.

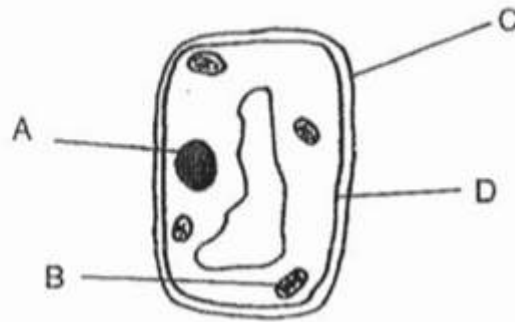

Which one of the following statements is correct?

	Part	Function
(1)	A	Controls activities in the cell.
(2)	B	Controls the movement of substances in and out of the cell.
(3)	C	Contains genetic information that is passed on from parents to their young.
(4)	D	Contains chlorophyll to trap sunlight.

- A) 1
 B) 2
 C) 3
 D) 4

Question 4 of 60

Primary 5 Science (Term 4)

1 pt

Anne observed an animal cell under a microscope as shown in diagram E. She then placed the cell in a liquid containing substance X.

After five minutes, she observed the cell again under the microscope as shown in diagram F.

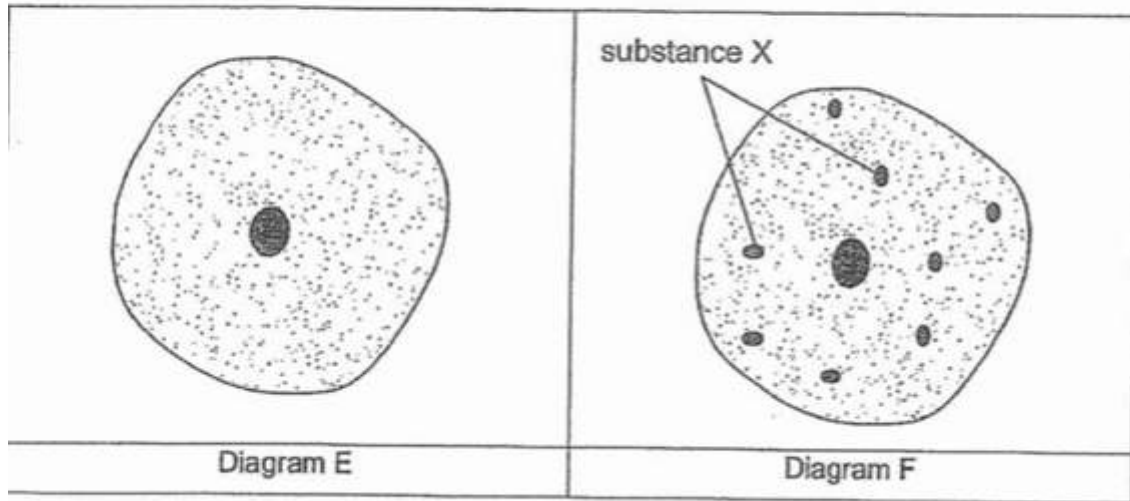

Which part of the cell allowed substance X to move into it?

- A) nucleus
- B) cell wall
- C) cytoplasm
- D) cell membrane

Question 5 of 60

Primary 5 Science (Term 4)

2 pts

The diagram shows the cross-section of a flower.

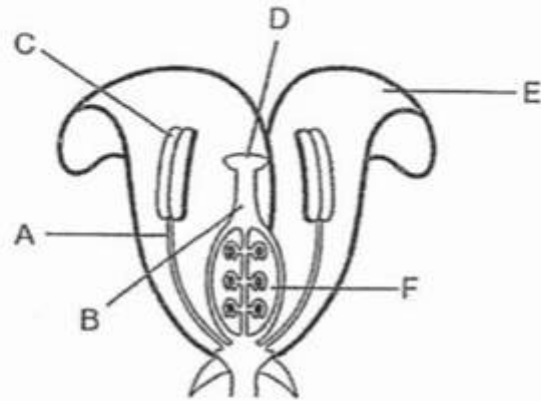

Which of the following correctly identifies the male and female parts of the flower?

	male parts	female parts
(1)	A and C	B, D and F
(2)	A, C and E	B, D and F
(3)	B, D and F	A and C
(4)	B, D and F	A, C and E

- A) 1
 B) 2
 C) 3
 D) 4

Question 6 of 60

Primary 5 Science (Term 4)

1 pt

Which one of the following graphs best represents the correct volume of oxygen, carbon dioxide and nitrogen found in inhaled air and exhaled air?

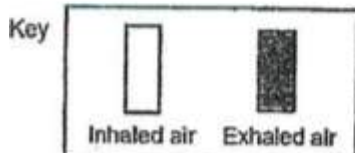
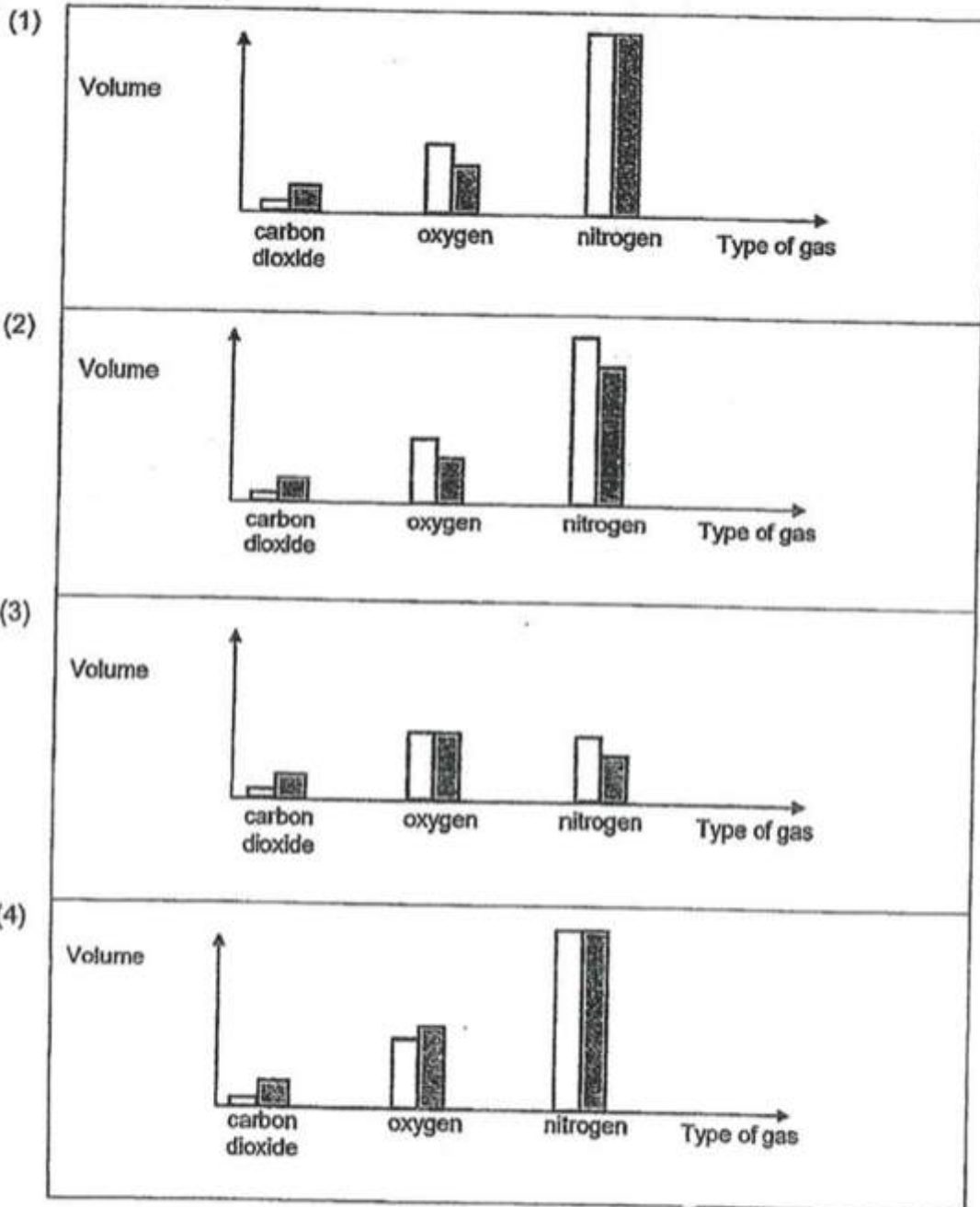

- A) 1
- B) 2
- C) 3
- D) 4

Question 7 of 60

Primary 5 Science (Term 4) 2 pts

Kim Chi wants to find out whether a fruit which she has picked up is dispersed the same way as the coconut.

Which of the following investigations should she carry out?

A Find the mass of the fruit by weighing it

B cut open the fruit to check if it has a fibrous husk

C Place the fruit in a basin of water to see if it can float

-
- A)** A and B only
- B)** C and B only
- C)** A and C only
- D)** A, B and C

Question 8 of 60

Primary 5 Science (Term 4)

2 pts

The diagrams show 6 tubes set up to investigate seed germination.

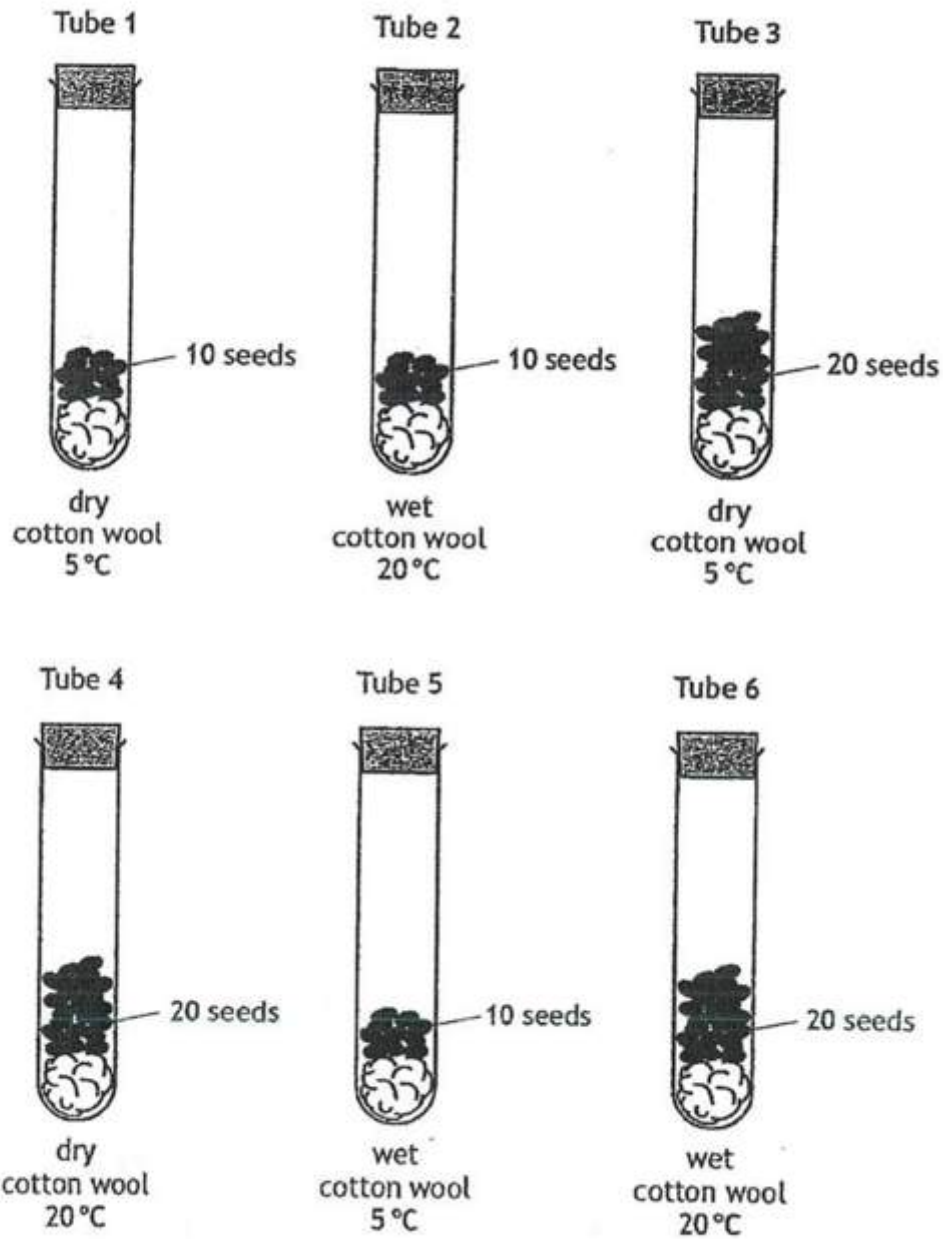

Based on tubes 1 to 6 given above, which two tubes should be compared to show the effect temperature has on germination?

- A) Tubes 1 and 3
- B) Tubes 6 and 3
- C) Tubes 6 and 4
- D) Tubes 2 and 5

Question 9 of 60

Primary 5 Science (Term 4)

2 pts

The diagram shows the human digestive system.

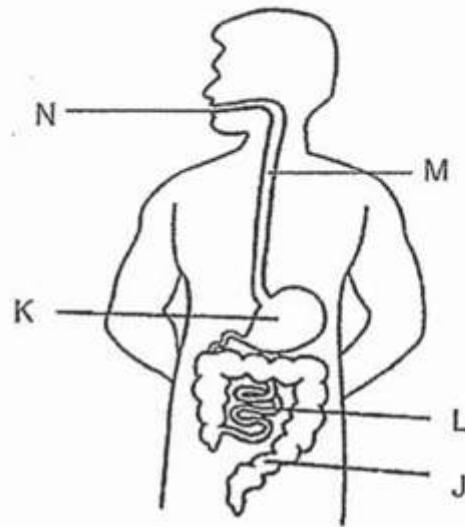

Based on the diagram given, which of the following is correct?

	organs that do not produce digestive juice	organ where digestion starts
(1)	M, J	N
(2)	M, N	J
(3)	N, K	J
(4)	M, K	N

- A) 1
 B) 2
 C) 3
 D) 4

Question 10 of 60

Primary 5 Science (Term 4)

2 pts

Which one of the following diagrams correctly shows the flow of water and food to the various parts of a plant?

(1)

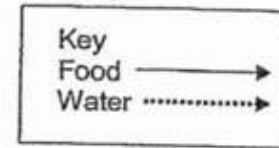
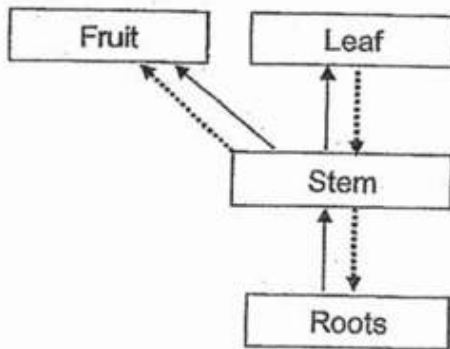

(2)

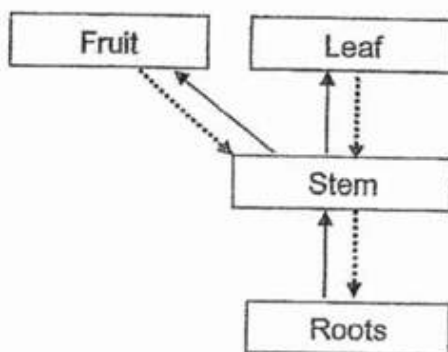

(3)

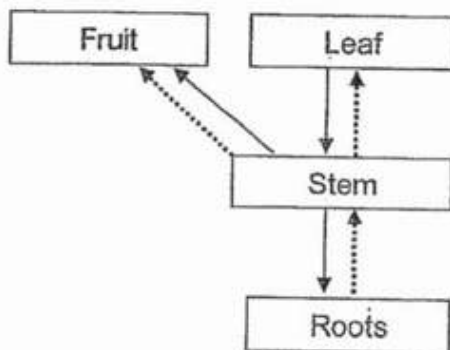

(4)

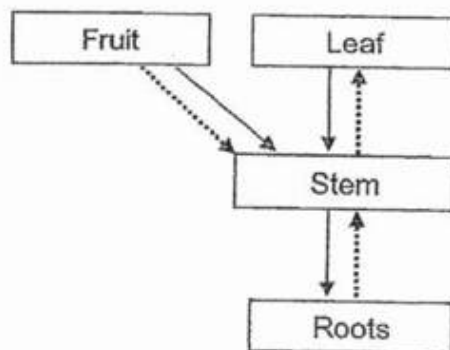

- A) 1
 B) 2
 C) 3
 D) 4

Question 11 of 60

Primary 5 Science (Term 4)

2 pts

The diagram shows the movement of substances between the lungs and the heart.

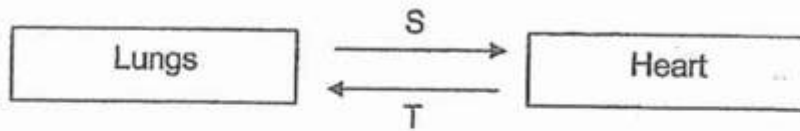

Based on the information given, which of the following is correct?

	S	T
(1)	Oxygen	Carbon dioxide
(2)	Carbon dioxide	Oxygen
(3)	Blood rich in oxygen	Blood rich in carbon dioxide
(4)	Blood rich in carbon dioxide	Blood rich in oxygen

- A) 1
- B) 2
- C) 3
- D) 4

Question 12 of 60

Primary 5 Science (Term 4)

2 pts

Dan placed a fresh celery stalk with leaves into a glass of red-coloured water as shown below.

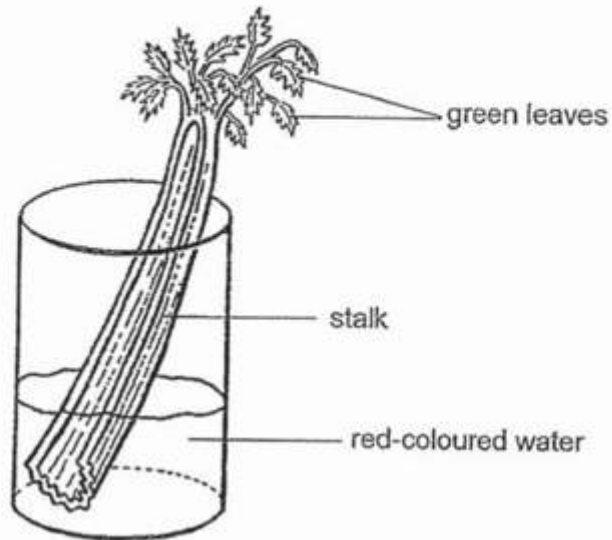

Which of the following correctly states and explains the observation Dan would make after 24 hours?

	Observation	Explanation
(1)	Leaves remained green.	Water-carrying tubes only transport the water and not the red colouring.
(2)	Leaves remained green.	Food-carrying tubes are damaged.
(3)	Leaves turned red.	Water-carrying tubes transport the red colouring to the leaves.
(4)	Leaves turned red.	Food-carrying tubes transport the red coloured water from the glass to the leaves.

- A) 1
 B) 2
 C) 3
 D) 4

Question 13 of 60

Primary 5 Science (Term 4)

2 pts

Statements A, B, C and D given below describe the processes of plant reproduction

A The male reproductive cell fuses with the female reproductive cell

B When a seed starts to germinate, the roots will appear first

C The fruit splits open and the seeds are carried away by the wind

D When the insects collect the nectar, they are also the transfer pollen grains to the stigma of another flower

In which order does the process of plant reproduction occur with one cycle?

-
- A) A,B,C,D
- B) A,C,B,D
- C) B,A,C,D
- D) D,B,C,A

Question 14 of 60

Primary 5 Science (Term 4)

2 pts

Different amounts of boiling water was poured into similar glass beakers, M and N, at the same time. The diagram shows the amount of boiling water in each beaker. The beakers were then left at the Science room.

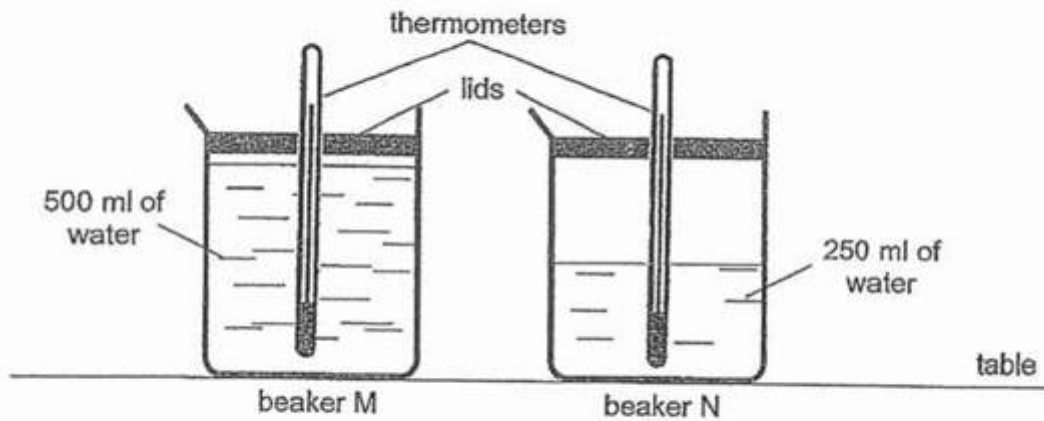

The temperature of water in beakers M and N was monitored and recorded over some time.

Which one of the following graphs best represents the results?

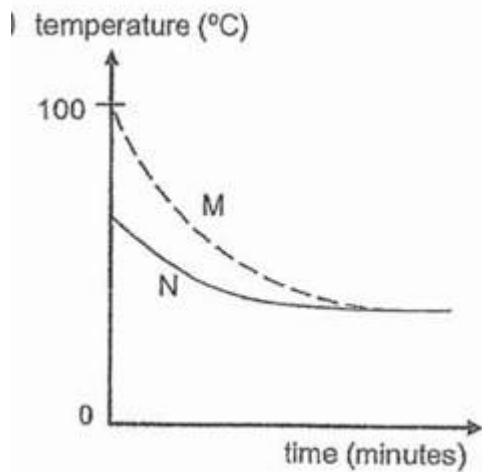
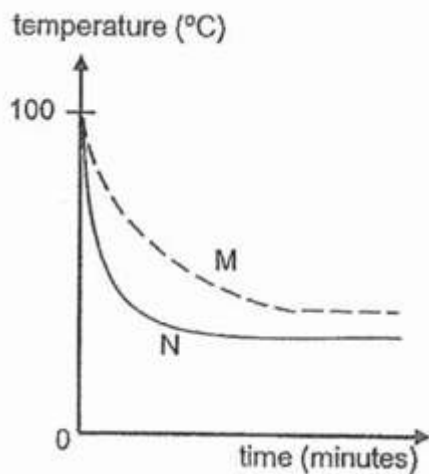
 A)

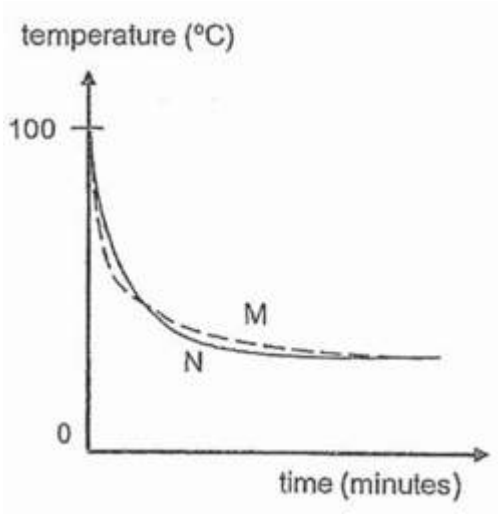
 B)

 C)

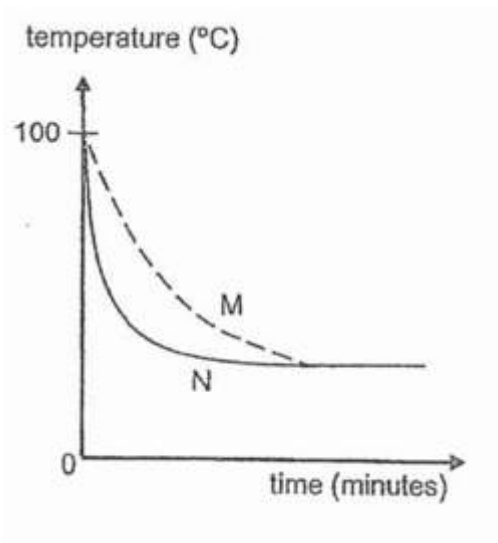

D)



Question 15 of 60

Primary 5 Science (Term 4)

2 pts



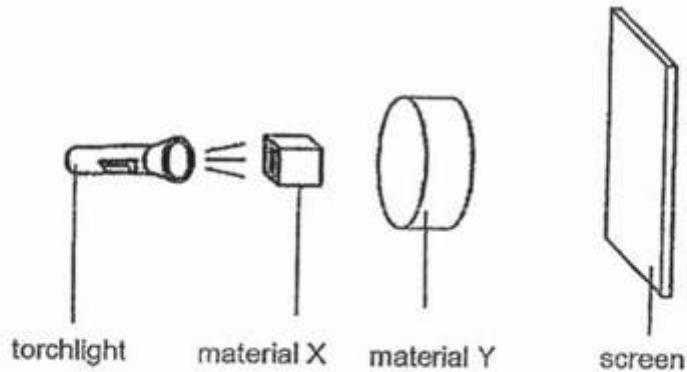

The table shows the amount of light that can pass through materials, X, Y and clear glass.

Material	Amount of light passing through (units)
X	0
Y	2500
Clear glass	5000

The diagram shows how materials X and Y are used in a set-up.



Which of the following shows the shadow likely to be formed on the screen?

- A) 
- B) 
- C) 
- D) 

Question 16 of 60

Primary 5 Science (Term 4)

2 pts

Jackson sets up an experiment as shown below.

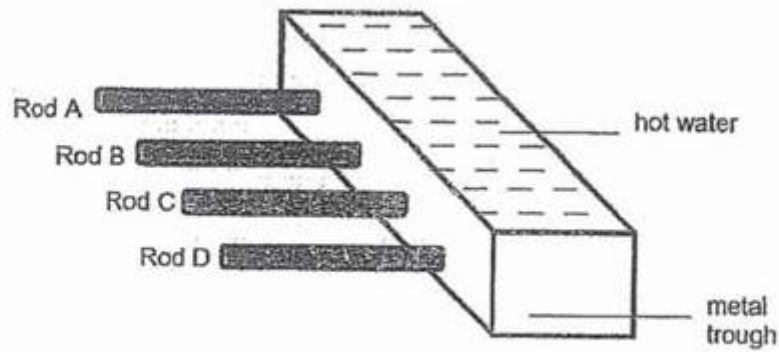

He used similar rods made of different materials. He coated all the rods with the same amount of wax. He then attached the rods to the metal trough containing hot water. After some time, he measured the length of wax melted on each of the four rods.

He plotted a graph as shown below.

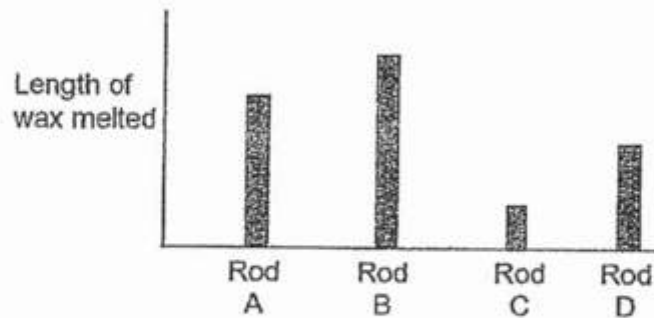

Which of the rods is made of the material that is the most suitable for making boxes for storing ice?

- A) A
 B) B
 C) C
 D) D

Question 17 of 60

Primary 5 Science (Term 4)

2 pts

Study the flow chart below.

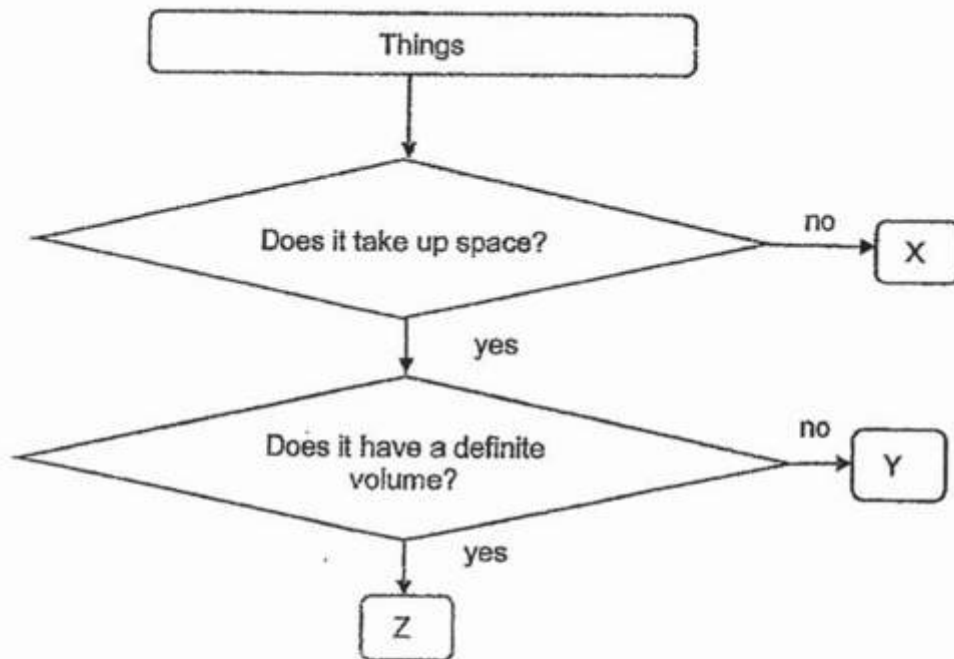

Which of the following correctly identifies the things X, Y and Z?

	X	Y	Z
(1)	Light	Water	Air
(2)	Shadow	Oxygen	Water
(3)	Music	Water vapour	Oxygen
(4)	Air	Water	Ice

- A) 1
 B) 2
 C) 3
 D) 4

Question 18 of 60

Primary 5 Science (Term 4)

2 pts

Ryan was given a 1000-cm^3 tank, which was filled with 400 cm^3 of water as shown below.

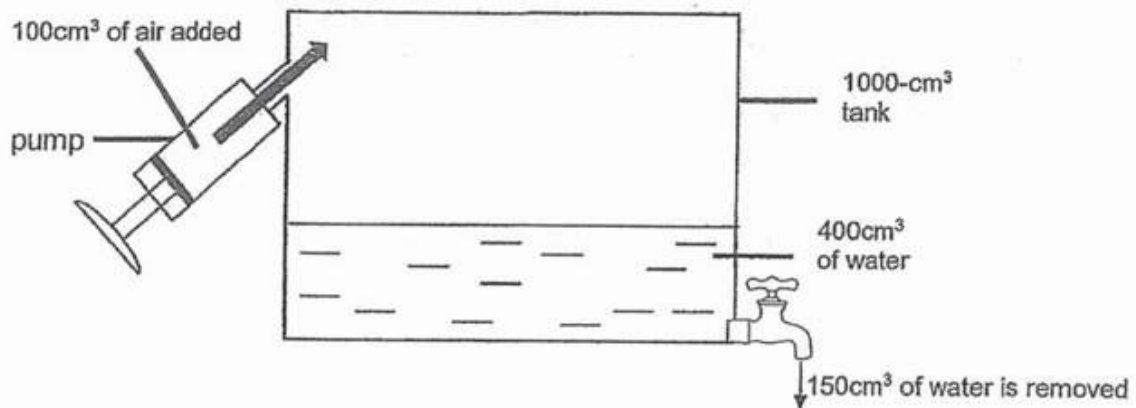

He removed 150cm^3 of water from the tank. Then, he used a pump to add 100 cm^3 of air into the container.

Based on the information given, which of the following correctly describes the mass of the air and its volume?

	mass of air	volume of air
(1)	increases	remains the same
(2)	decreases	remains the same
(3)	remains the same	increases
(4)	increases	increases

()

- A) 1
 B) 2
 C) 3
 D) 4

Question 19 of 60

Primary 5 Science (Term 4)

2 pts

The diagram shows the water cycle.

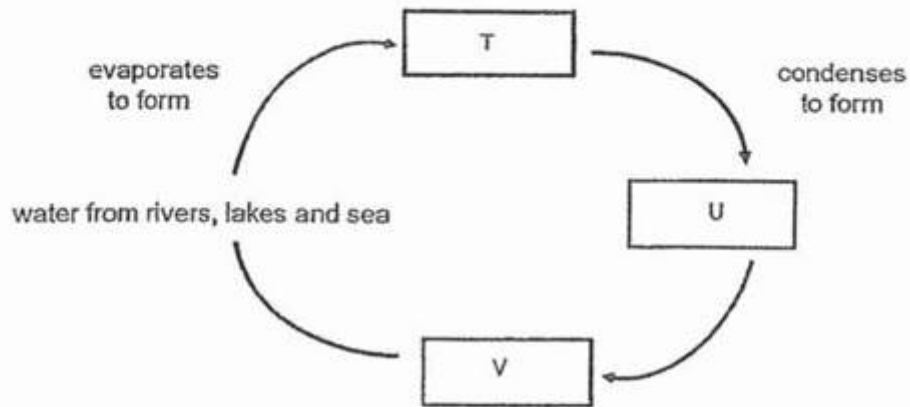

Which of the following correctly identifies T, U and V from the diagram above?

	T	U	V
(1)	rain	clouds	water vapour
(2)	water vapour	clouds	rain
(3)	clouds	rain	water vapour
(4)	water vapour	rain	clouds

- A) 1
 B) 2
 C) 3
 D) 4

Question 20 of 60

Primary 5 Science (Term 4)

2 pts

Faith wants to find out what factors affect the rate at which water evaporates. She carried out an experiment using the 5 beakers as shown in the table below.

Beaker	Volume of water at the start of the experiment (ml)	Surrounding temperature (°C)	Exposed surface area	Volume of water at the end of experiment (ml)
P	300	40	Large	200
Q	300	40	Small	260
R	300	80	Large	150
S	350	40	Large	200
T	350	80	Small	220

If she wants to find out whether temperature affects the rate of evaporation, which two beakers should she use in order to ensure a fair test?

-
- A) P and R
- B) Q and T
- C) R and S
- D) P and Q

Question 21 of 60

Primary 5 Science (Term 4)

2 pts

The diagram shows a pot of melted chocolate.

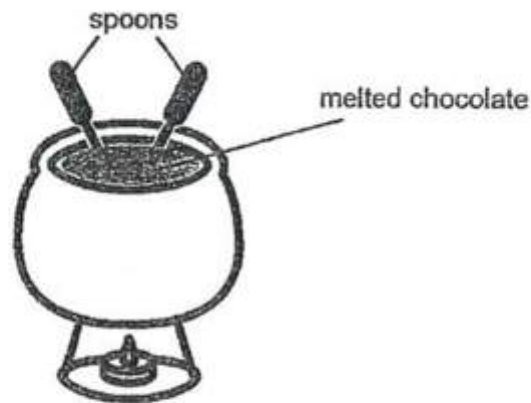

John puts a metal spoon and a wooden spoon in the pot of melted chocolate. When he lifted the spoons out from the pot of melted chocolate, he noticed that the melted chocolate on the metal spoon solidifies faster than the chocolate on the wooden spoon.

Which one of the following correctly explains why?

-
- A) The melted chocolate on the wooden spoon gained heat faster than from the metal spoon
 - B) The melted chocolate on the wooden spoon lost heat faster than from the metal spoon
 - C) The melted chocolate on the metal spoon gained heat faster than from the wooden spoon
 - D) The melted chocolate on the metal spoon lost heat faster than from the wooden spoon

Question 22 of 60

Primary 5 Science (Term 4)

2 pts

Dr Liu wears a face shield as shown below.

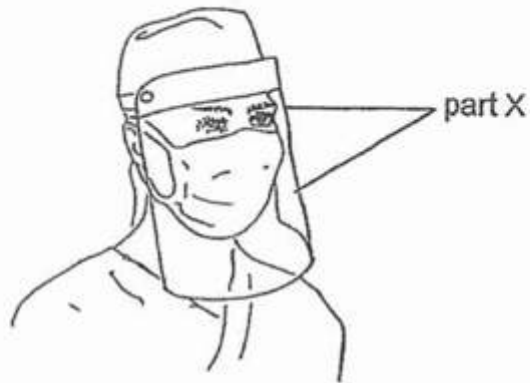

Part X of the face shield protects his eyes from droplets that may contain viruses. Material Y is used to make part X.

Based on information given, which one of the properties best explains why material Y is chosen?

Material Y is _____.

- A) strong
- B) waterproof
- C) able to float
- D) able to conduct heat slowly

Question 23 of 60

Primary 5 Science (Term 4)

2 pts

David conducted an experiment with three objects, X, Y and Z. He tried to put two objects near each other as shown in the diagrams below.

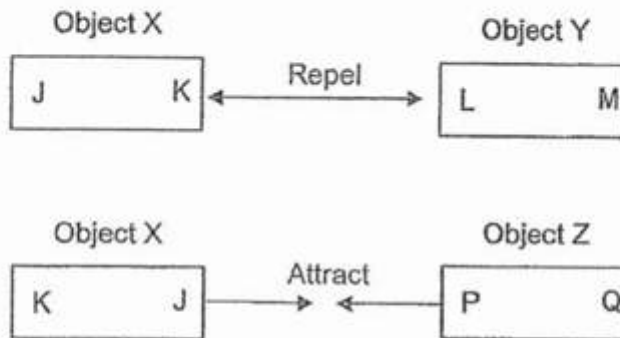

Which of the following(s) is/are correct?

- A K and L are like poles.
- B Object Y is a non-magnetic object.
- C Object Z is a non-magnetic object.
- D M and Q are unlike poles.

- A) A only
- B) A and C only
- C) B and C only
- D) B, D and C only

Question 24 of 60

Primary 5 Science (Term 4)

2 pts

Niles turned a nail into an electromagnet using the set-up shown below. He then brought paper clips to test the strength of the electromagnet. He did this each time there is a change in the number of batteries and coils.

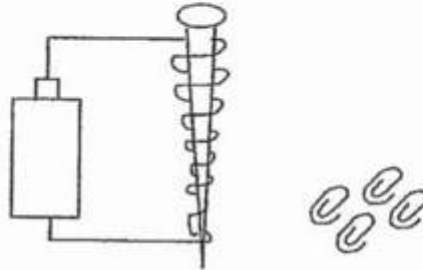

The table below shows the result.

Number of coils	Number of batteries	Number of paper clips attracted
20	4	13
40	4	26
20	6	X
20	8	34
40	6	48

What is the value of X in the table shown above?

- A) 12
- B) 23
- C) 36
- D) 44

Question 25 of 60

Primary 5 Science (Term 4)

2 pts

Study the circuit diagram shown.

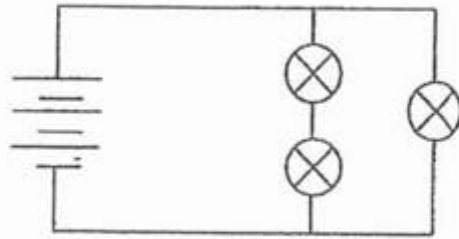

Which one of the following correctly represents the circuit shown above?

A)

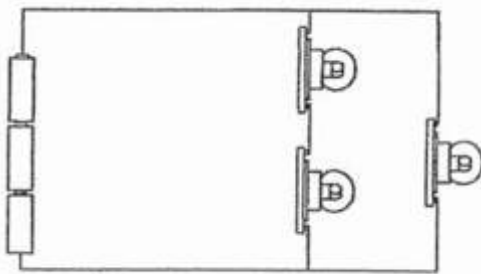

B)

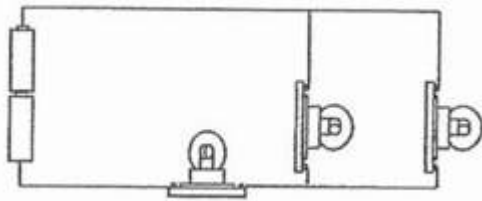

C)

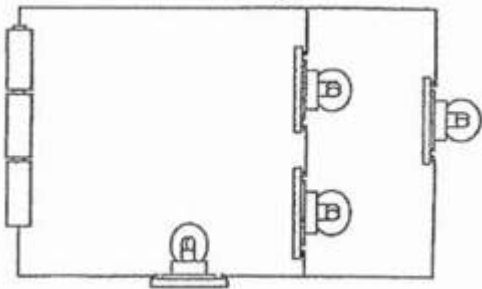

D)

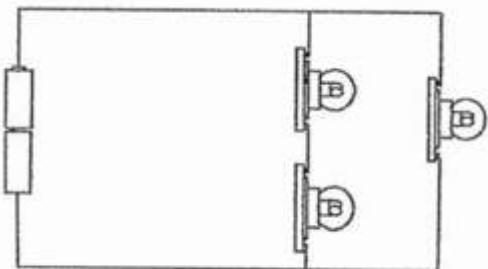

Question 26 of 60

Primary 5 Science (Term 4)

2 pts

Four rods made of different materials, wood, glass, iron and copper, were connected in the electrical circuit as shown below.

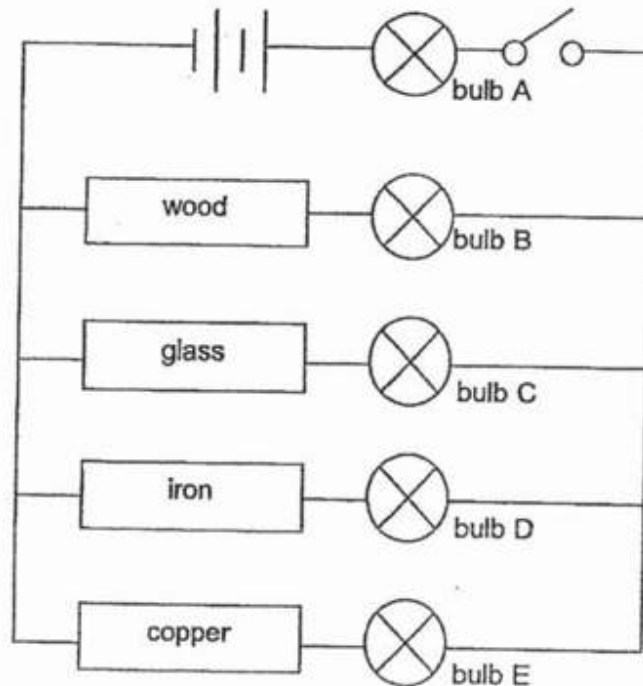

Which bulbs will light up after the switch is closed?

- A) B and C only
- B) D and E only
- C) A, D and E only
- D) B, D, C and E only

Question 27 of 60

Primary 5 Science (Term 4)

2 pts

Nicholas bought two different brands of light bulb. He wanted to find out which brand of light is brighter.

Which of the following variable(s) should he keep the same to ensure a fair test?

- A Brand of bulbs
- B Number of bulbs
- C Brand of batteries
- D Arrangement of bulbs

- A) A and B only
- B) B and C only
- C) B, C and D only
- D) A, C and D only

Question 28 of 60

Primary 5 Science (Term 4)

2 pts

Ethan set up the circuits shown below with identical bulbs and batteries.

Set-up 1

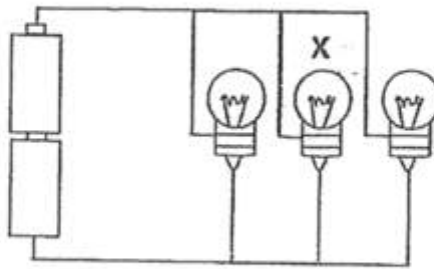

Set-up 2

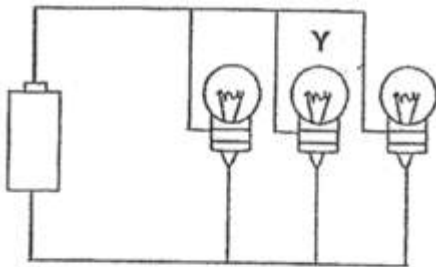

Set-up 3

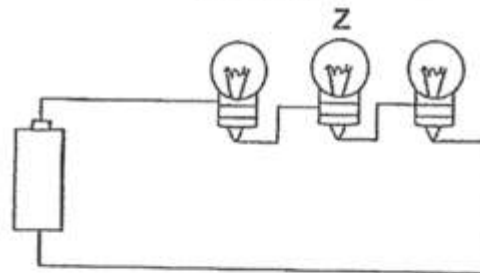

Which of the following statements about the bulbs in the above circuits are not correct?

- A Bulb Z is dimmer than bulb Y.
- B Bulbs X and Y have the same brightness.
- C If bulb X is removed from its circuit, the remaining bulbs will become dimmer.

- A) A and B only
- B) C and B only
- C) A and C only
- D) A, B and C

Question 29 of 60

Primary 5 Science (Term 4)

2 pts

Part A is found on the leaves of a plant as shown in the diagram below.

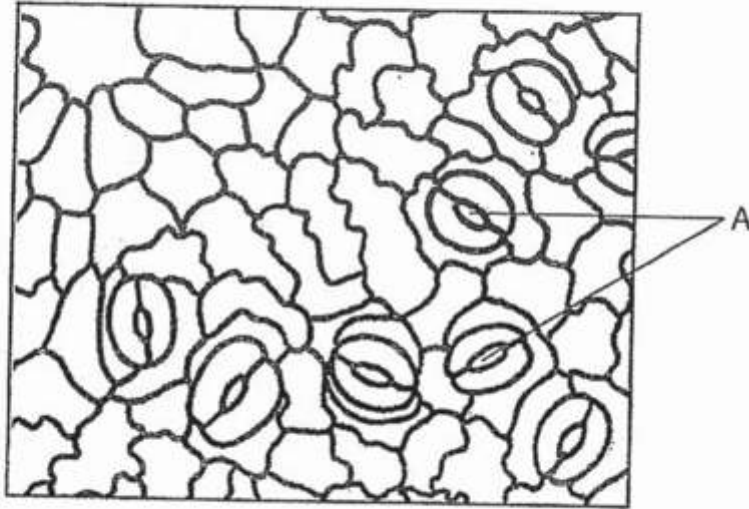

a) State what part A is: _____

Question 30 of 60

Primary 5 Science (Term 4)

0 pts

b) Oil is used to cover all the parts A found on all the leaves of the plant.
What would likely happen to the plant if the oil is left on the leaves for a long period of time?

Question 31 of 60

Primary 5 Science (Term 4)

0 pts

c) Explain your answer in (b)

Question 32 of 60

Primary 5 Science (Term 4)

1 pt

The diagrams show two reproductive cells, X and Y, in the human reproductive system.

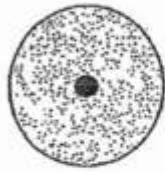

Cell X



Cell Y

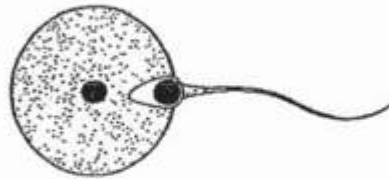

Process Z

Name the reproductive organ that produces:

[1]

(i) Cell X

Question 33 of 60

Primary 5 Science (Term 4)

1 pt

Cell Y: _____

Question 34 of 60

Primary 5 Science (Term 4)

1 pt

Name process Z

Question 35 of 60

Primary 5 Science (Term 4)

0 pts

c) Farmer Li grows plant Q in his farm that has only red flowers.

He collected seeds from plant Q with pink flowers and planted them to grow new plants.

Explain why the new plants will only have pink flowers

Question 36 of 60

Primary 5 Science (Term 4)

0 pts

Tim counted the number of two different types of young plants, A and B, at different distances from their parent plants in a large field. The results are shown in the table below.

Distance from parent plant (m)	Number of young plants	
	A	B
0	0	0
2	8	2
4	6	3
6	4	5

Based on his results, which young plant, A or B, will have to compete more with their parents for survival? Explain your answer.

Question 37 of 60

Primary 5 Science (Term 4)

0 pts

The diagrams show the fruits of plants A and B.

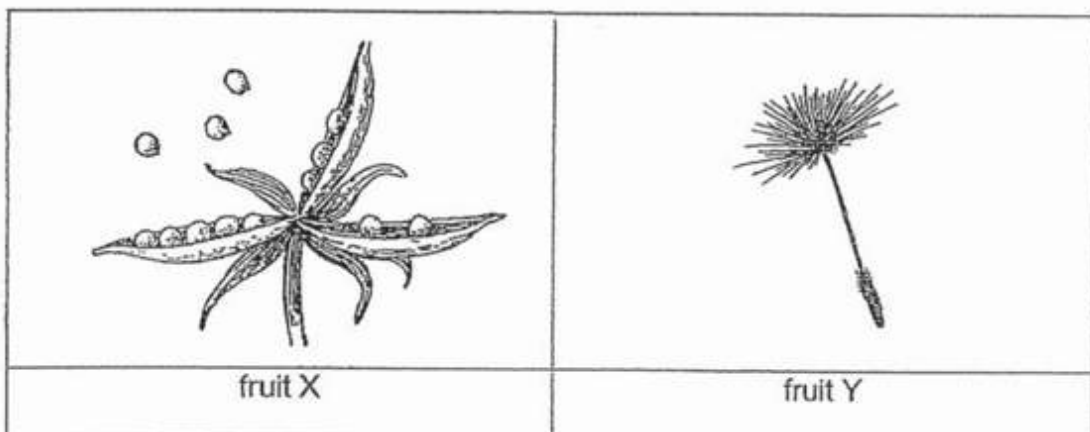

(b) Which fruit, X or Y, is the fruit of plant A?

Explain your answer.

Question 38 of 60

Primary 5 Science (Term 4)

0 pts

Plant transport system consists of two types of tubes, water-carrying tubes and food-carrying tubes.

In the table below, put a tick (✓) in the correct boxes to indicate where the food-carrying tubes can be found in a plant.

[2]

Where food-carrying tubes can be found in the plant			
stem	root	leaf	flower

Question 39 of 60

Primary 5 Science (Term 4)

0 pts



(b) The insects are found eating through a stem of the plant.

Explain how this affects the growth of the roots of the plant.

Question 40 of 60

Primary 5 Science (Term 4)

0 pts

The graph shows how Javier's heart rate changes over time.

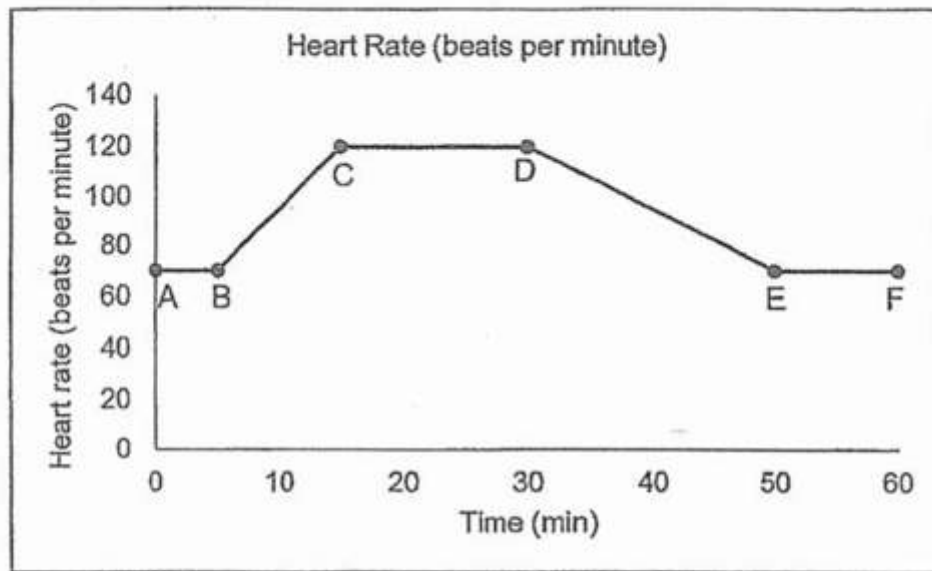

Match the activities in the table below according to his heart rate shown in the graph by writing AB, BC, CD, DE or EF in the correct boxes.

(i)	Started jogging	
(ii)	Cooling down exercise	

Question 41 of 60

Primary 5 Science (Term 4)

0 pts

b) At which part, AB or BC, did Javier take in more oxygen? Explain your answer

Question 42 of 60

Primary 5 Science (Term 4) 0 pts

Hector went on a holiday during winter. He noticed that he could see a 'white cloud' coming out of his mouth as he breathed out as shown in the diagram below.



State what the 'white cloud' is.

[1]

Question 43 of 60

Primary 5 Science (Term 4) 0 pts

b) Explain how the "white cloud" is formed

Question 44 of 60

Primary 5 Science (Term 4) 0 pts

c) Hector needed to wear a thick winter jacket to keep him warm because of the low surrounding temperature.

Explain why he was able to keep himself warm by wearing the thick winter jacket

Question 45 of 60

Primary 5 Science (Term 4) 0 pts

Fabien has three balls, P, Q and R, made of different materials. He dropped ball P into a beaker of liquid Z.

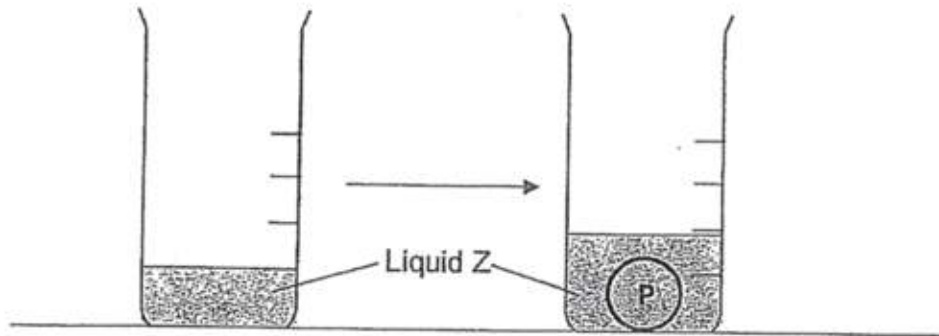

He noticed that the level of liquid Z increases after ball P is dropped into it. Explain why.

Question 46 of 60

Primary 5 Science (Term 4) 0 pts

b) Fabian's teacher, Mrs Tan, said that ball P is a matter. State what a matter is.

Question 47 of 60

Primary 5 Science (Term 4)

1 pt

Tick the instrument that Fabien can use to measure the amount of matter in ball P

 A)

Beam balance

 B)

Ruler

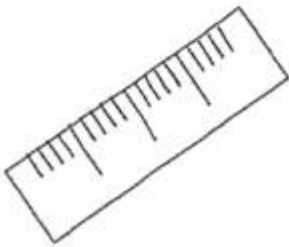
 C)

Stopwatch

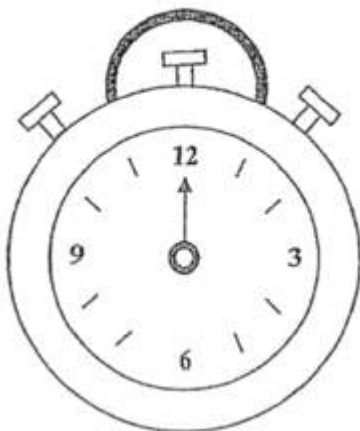

Question 48 of 60

Primary 5 Science (Term 4) 0 pts

Danny conducted an experiment by placing two beakers, A and B, each containing 60 ml of tap water in the same room.



He then measured the volume of the tap water remaining in each beaker after some time. He recorded his results in the table as shown below.

Beaker	Exposed surface area (cm ²)	Volume of tap water remaining (ml)
A	20	55
B	35	40

Based on the table above, explain how the difference in the exposed surface area affects the amount of tap water lost.

[1]

Question 49 of 60

Primary 5 Science (Term 4) 0 pts

Danny conducted his second experiment by using two similar beakers, C and D, each containing 60ml of tap water.

He placed the tap water in Container C in a dim room while the tap water in Container D under a brightly lit lamp.

He recorded his results in the table as shown below.

Beaker	Exposed surface area (cm ²)	Temperature of surrounding (°C)	Volume of tap water remaining (ml)
C	35	25	58
D	35	32	20

From the table above, state the aim of Danny's second experiment.

Question 50 of 60

Primary 5 Science (Term 4) 0 pts

c) What is the relationship between the temperature of the surrounding and the volume of tap water remaining?

Question 51 of 60

Primary 5 Science (Term 4) 0 pts

Ian uses an electrical hot plate to boil two similar beakers of water. Each beaker contains different amount of water.

He wanted to find out which beaker of water, X or Y, will boil first.

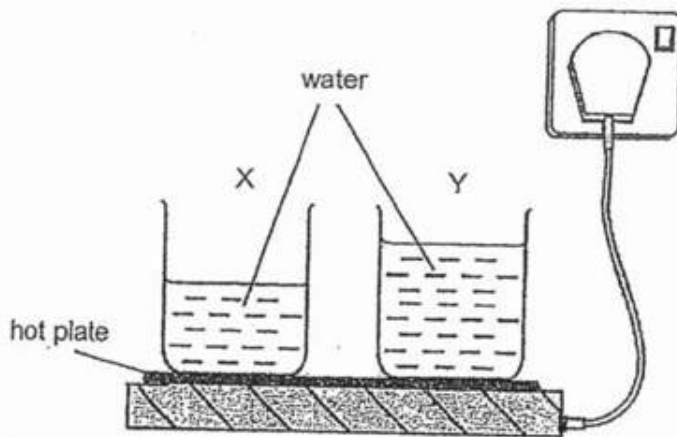

	Beaker X	Beaker Y
Volume of water (ml)	150	200
Temperature of water before heating (°C)	32	32

State a similarity between evaporation and boiling.

[1]

Question 52 of 60

Primary 5 Science (Term 4) 0 pts

b) Which beaker of water, X or Y, will boil first?

Question 53 of 60

Primary 5 Science (Term 4) 0 pts

c) Explain your answer in (b)

Question 54 of 60

Primary 5 Science (Term 4) 0 pts

Ian used a thick glass cup to make tea as shown below.

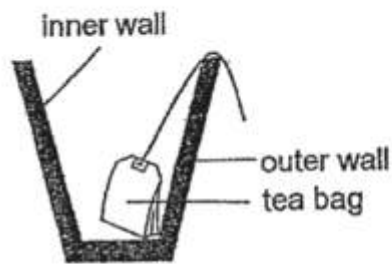

Cup made of thick glass

(d) When he poured boiling water into the glass cup, it cracked.

Explain why.

Question 55 of 60

Primary 5 Science (Term 4)

0 pts

- Jia Jie conducted an experiment using three similar strips, A, B and C. Each strip is made of a different material.

He suspended each strip from a string and dipped one end into a container of red-coloured water as shown below.

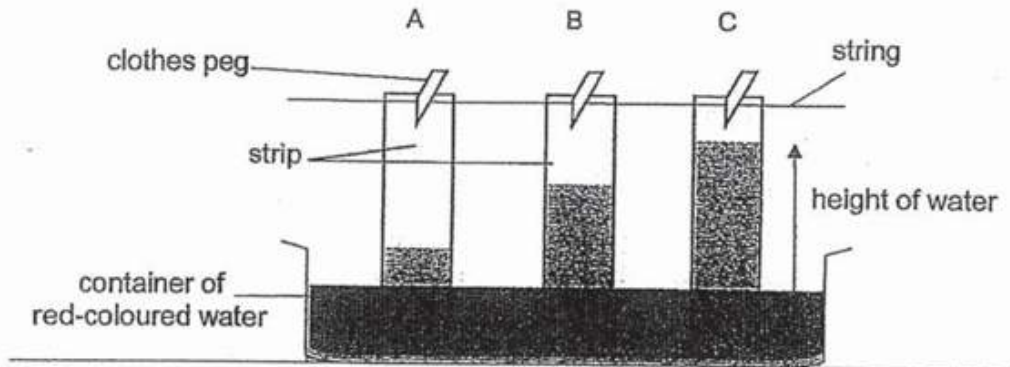

He measured the height of water that travels up each strip after 10 minutes. The result is shown in the table below.

Strip	Height of water (cm)
A	0
B	10
C	15

State the independent and dependent variables in Jia Jie's experiment.

[1]

Independent variable : _____

Dependent variable: _____

Question 56 of 60

Primary 5 Science (Term 4)

1 pt

Which strip of material is most suitable to make a bath mat?

- A) A
- B) B
- C) C

Question 57 of 60

Primary 5 Science (Term 4)

0 pts

Explain your answer in (b)

Question 58 of 60

Primary 5 Science (Term 4)

0 pts

Study the table below.

	Material		
	X	Y	Z
Does it allow most light to pass through?	Yes	No	No
Does it bend easily without breaking?	No	Yes	Yes
Does it break easily?	No	No	Yes
Does it absorb water?	No	No	Yes

Kelly wanted to make a container to store sugar as shown below.

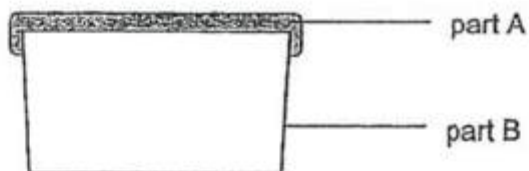

When placed on a shelf, she could see easily the sugar in the container. The container also kept water away from the sugar. Part A can be bent easily so that she can pull it to open and push it to close the container.

Which material (X, Y or Z) should she choose to make parts A and B of the container?

Explain why.

Part A:

Explanation:

Part B:

Explanation:

Question 59 of 60

Primary 5 Science (Term 4) 0 pts

Lena has a switch and two bulbs, A and B. She set up an electrical circuit as shown below.

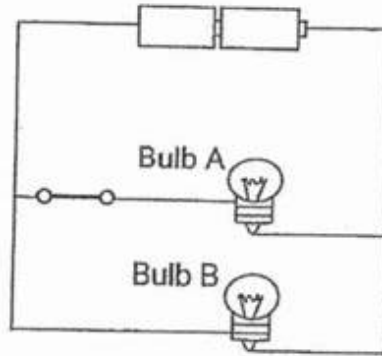

When the switch is opened, what will happen to bulb A and bulb B? Give a reason for your answer.

Bulb A:

Reason:

Bulb B:

Reason:

Question 60 of 60

Primary 5 Science (Term 4)

0 pts

Lena wants the switch to be able to turn off the two bulbs at the same time by rearranging the wires. Lena also wants the brightness of the two bulbs to remain the same.

Draw lines (representing the wires) in the diagram below to reconnect the circuit again.

